

To choose congregated high quality
product as you wish...

CHYT

Zhejiang Dabo Electric Co., Ltd.

Catalogue of Products

International quality of Shouxin

Shared By the Global

to start the brilliant and lustrous new life with you together

.....

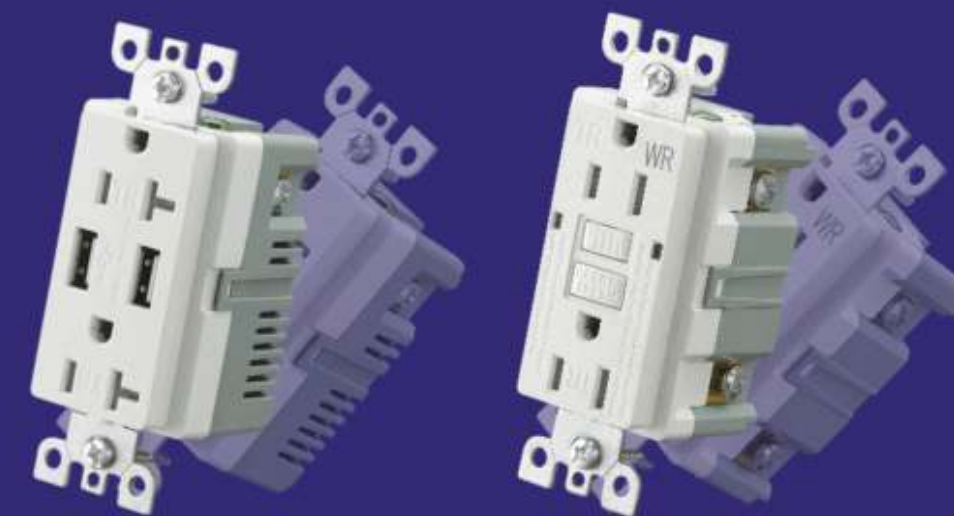

Contact Us:

Zhejiang Dabo Electric Co., Ltd.

Add: XiangyangIndustrialzone,Liushitown,
Yueqing,Zhejiang,China.

Tel:+86-15058987111

E-mail:chyt@chyt-solar.com

Web:www.chyt-solar.com

<https://chyatai.en.alibaba.com>

To choose congregated high quality product as you wish...



Company Profile

Zhejiang Dabo Electric Co., Ltd. is a professional solar PV electric components manufacturer located in Yueqing City, China. We're specialized in DC circuit breakers, Surge Protective Devices, PV fuses, isolator switches, MC4 connectors etc.

Our experience of working in the electrical industry for more than 10 years allows us to create solar DC components that comply with the latest DC standards. We can assure you perfect quality and excellent service. We're looking forward to having a good-long term cooperaton with you and your company.



To choose congregated high quality product as you wish...



Advancing side by side with multiple, developing with scale.....

Technology input and expectant prospect are required for developing enterprise. "Dabo Technology" is standing at the front line of the industry, on the basis of developing international building electric products as main direction of management, continuously widen the trains of thoughts for developing enterprise forwardly, devoting to the development parttern of multiple, industrialization and grouping to form scale situcrtion, thereby fo create the brand road of enterprise...





Tamper-Resistant and Non Tamper-Resistant Self-Test GFCI Receptacles

THE CHYT Series GFCIs are the latest innovation in ground fault circuit interrupter protection. Easy to install, The GFCIs provide all the lockout benefits of our standard CHYT offering, and are available in tamper-resistant and non tamper-resistant versions. Constructed of resilient thermoplastic able to withstand high torque levels, GFCIs come in styles for every need, including a combination guide light/receptacle and a self-test device. Engineered to meet the latest UL standard for auto-monitoring (self-test), our complete line of self-test GFCIs periodically conduct an automatic internal test to confirm that protected power is available. When it comes to smart GFCI protection, CHYT is certainly in.

TST15-WH

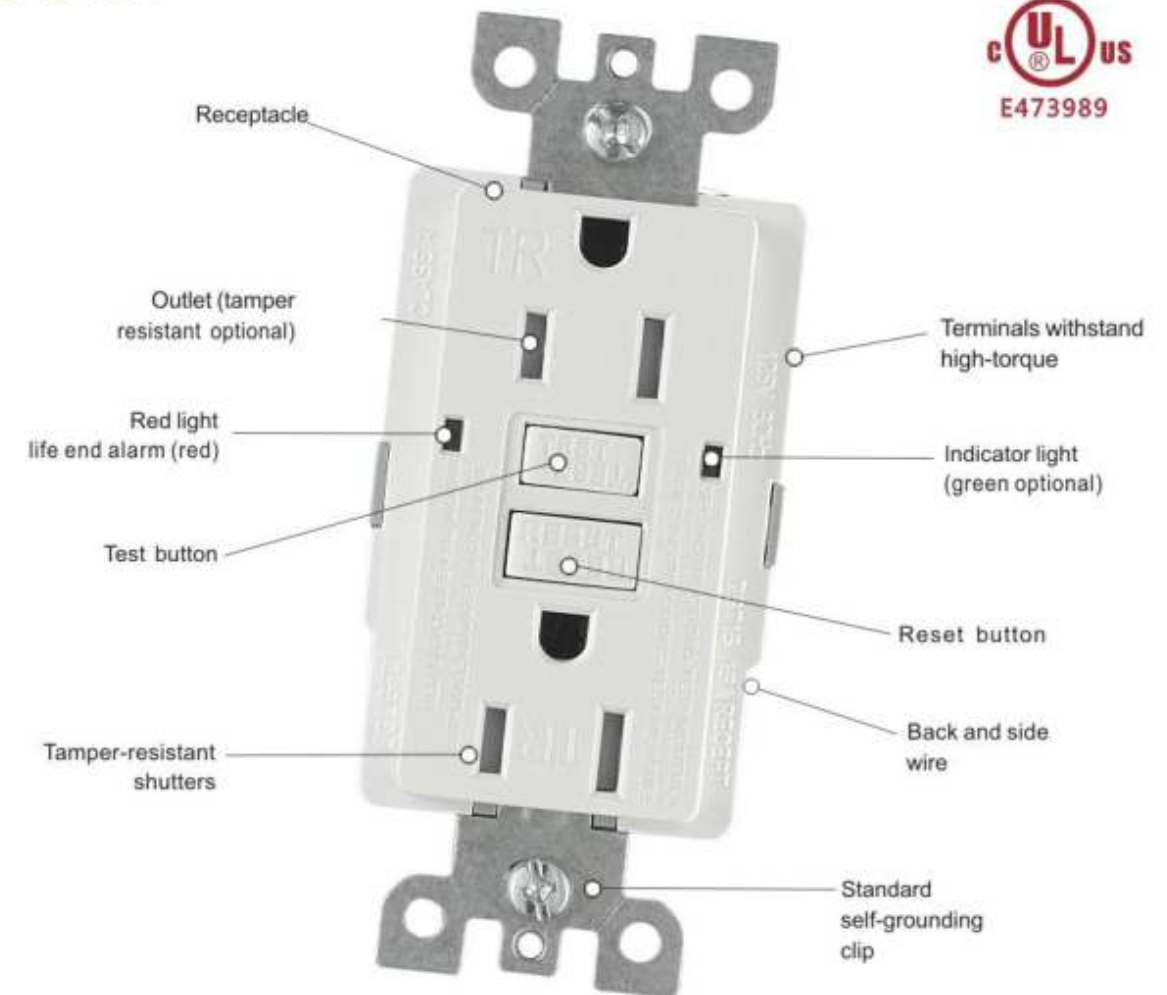

Contents

To choose congregated high quality products as you wish.....



UL 2015 Self Test GFCI Series	01
Latest Self Test GFCI Series	04
UL 2017 Self Test GFCI Series	06
GFCI products for industrial generators	09
2010 Regular GFCI Series	10
USB Charger Receptacles Series	14
Receptacles Series	15
Switch Series	21
Wall plate Series	23
Steel Wall Plate Series	31

Color Choices GFCI receptacles are offered in a wide range of colors. To order colors, add suffix to Cat.No.





CHYT

GFCI wall socket

- Duplex leakage current protection
- Anti-UV radiation PC Material
- Silver alloy contacts
- Smart identification chip
- UL and CUL certified

TS SERIES



TS15

DESCRIPTION

GFCI Duplex Receptacle
15A 125V AC 60Hz
Self-Test UL943

ART. NO

TS15 WH
TS15 IV
TS15 AL
TS15 BK
TS15 GR

BODY COLOR

White
Ivory
Almond
Black
Grey



TS20

DESCRIPTION

GFCI Duplex Receptacle
20A 125V AC 60Hz
Self-Test UL943

ART. NO

TS20 WH
TS20 IV
TS20 AL
TS20 BK
TS20 GR

BODY COLOR

White
Ivory
Almond
Black
Grey



TSI

DESCRIPTION

Dead Front GFCI
20A 125V AC 60Hz
Self-Test UL943

ART. NO

TSI WH
TSI IV
TSI AL
TSI BK
TSI GR

BODY COLOR

White
Ivory
Almond
Black
Grey



CHYT



TST15

DESCRIPTION

GFCI Duplex
15A 125V AC 60Hz
Tamper Resistant
Self-Test UL943

ART. NO

TST15 WH
TST15 IV
TST15 AL
TST15 BK
TST15 GR

BODY COLOR

White
Ivory
Almond
Black
Grey



TST20

DESCRIPTION

GFCI Duplex
20A 125V AC 60Hz
Tamper Resistant
Self-Test UL943

ART. NO

TST20 WH
TST20 IV
TST20 AL
TST20 BK
TST20 GR

BODY COLOR

White
Ivory
Almond
Black
Grey



WTST15

DESCRIPTION

GFCI Duplex
15A 125V AC 60Hz
Tamper Resistant
Weather Resistant
Self-Test UL943

ART. NO

WTST15 WH
WTST15 IV
WTST15 AL
WTST15 BK
WTST15 GR

BODY COLOR

White
Ivory
Almond
Black
Grey



WTST20

DESCRIPTION

GFCI Duplex
20A 125V AC 60Hz
Tamper Resistant
Weather Resistant
Self-Test UL943

ART. NO

WTST20 WH
WTST20 IV
WTST20 AL
WTST20 BK
WTST20 GR

BODY COLOR

White
Ivory
Almond
Black
Grey





CHYT

GFCI wall socket

- Duplex leakage current protection
- Anti-UV radiation PC Material
- Silver alloy contacts
- Smart identification chip
- UL and CUL certified

Latest GFCI Series
Auto-Trip Function Once Problem is detected



TS15

DESCRIPTION
GFCI Duplex
15A 125V AC 60Hz
Self-Test UL943

ART. NO
TS15 WH
TS15 IV
TS15 AL
TS15 BK
TS15 GR

BODY COLOR
White
Ivory
Almond
Black
Grey



TS20

DESCRIPTION
GFCI Duplex
20A 125V AC 60Hz
Self-Test UL943

ART. NO
TS20 WH
TS20 IV
TS20 AL
TS20 BK
TS20 GR

BODY COLOR
White
Ivory
Almond
Black
Grey



TST15

DESCRIPTION
GFCI Duplex
15A 125V AC 60Hz
Tamper Resistant
Self-Test UL943

ART. NO
TST15 WH
TST15 IV
TST15 AL
TST15 BK
TST15 GR

BODY COLOR
White
Ivory
Almond
Black
Grey



CHYT



TST20

DESCRIPTION
GFCI Duplex
20A 125V AC 60Hz
Tamper Resistant
Self-Test UL943

ART. NO
TST20 WH
TST20 IV
TST20 AL
TST20 BK
TST20 GR

BODY COLOR
White
Ivory
Almond
Black
Grey



WTST15

DESCRIPTION
GFCI Duplex
15A 125V AC 60Hz
Tamper Resistant
Weather Resistant
Self-Test UL943

ART. NO
WTST15 WH
WTST15 IV
WTST15 AL
WTST15 BK
WTST15 GR

BODY COLOR
White
Ivory
Almond
Black
Grey



WTST20

DESCRIPTION
GFCI Duplex
20A 125V AC 60Hz
Tamper Resistant
Weather Resistant
Self-Test UL943

ART. NO
WTST20 WH
WTST20 IV
WTST20 AL
WTST20 BK
WTST20 GR

BODY COLOR
White
Ivory
Almond
Black
Grey





TSTL Series



TST15L

DESCRIPTION

GFCI Duplex
15A 125V AC 60Hz
Tamper Resistant
Self-Test UL943

ART. NO

TST15L WH
TST15L IV
TST15L AL
TST15L BK
TST15L GR

BODY COLOR

White
Ivory
Almond
Black
Grey



TST20L

DESCRIPTION

GFCI Duplex
20A 125V AC 60Hz
Tamper Resistant
Self-Test UL943

ART. NO

TST20L WH
TST20L IV
TST20L AL
TST20L BK
TST20L GR

BODY COLOR

White
Ivory
Almond
Black
Grey



WTST15L

DESCRIPTION

GFCI Duplex
15A 125V AC 60Hz
Tamper Resistant
Weather Resistant
Self-Test UL943

ART. NO

WTST15L WH
WTST15L IV
WTST15L AL
WTST15L BK
WTST15L GR

BODY COLOR

White
Ivory
Almond
Black
Grey



WTST20L

DESCRIPTION

GFCI Duplex
20A 125V AC 60Hz
Tamper Resistant
Weather Resistant
Self-Test UL943

ART. NO

WTST20L WH
WTST20L IV
WTST20L AL
WTST20L BK
WTST20L GR

BODY COLOR

White
Ivory
Almond
Black
Grey



TS15L

DESCRIPTION

GFCI Duplex
15A 125V AC 60Hz
Self-Test UL943

ART. NO

TS15L WH
TS15L IV
TS15L AL
TS15L BK
TS15L GR

BODY COLOR

White
Ivory
Almond
Black
Grey



TS20L

DESCRIPTION

GFCI Duplex
20A 125V AC 60Hz
Self-Test UL943

ART. NO

TS20L WH
TS20L IV
TS20L AL
TS20L BK
TS20L GR

BODY COLOR

White
Ivory
Almond
Black
Grey



TSIL

DESCRIPTION

Dead Front GFCI
20A 125V AC 60Hz
Self-Test UL943

ART. NO

TSIL WH
TSIL IV
TSIL AL
TSIL BK
TSIL GR

BODY COLOR

White
Ivory
Almond
Black
Grey



TS TST, TSTL Series

Features and Benefits

Self-Test

- Provides continuous ground fault protection - detects and trips on actual ground fault even when self-test is being conducted
- On initial power up, tests the GFCI within 3 seconds
- Auto-monitoring exceeds the UL requirement
- Auto adapts and shifts to more frequent testing if potential problem is detected
- Testing frequency regularly updates protection status
- Electronics are designed to minimize any false triggers

General Features

- Trip threshold meets or exceeds UL requirements for tripping time
- Improved immunity to high frequency noise reduces nuisance tripping
- Advanced electronics provides superior resistance to electrical surges and over-voltages
- Status Indicator Light provides simple, intuitive feedback on power and protection status as well as indication of line/load reversal
- Silver alloy contacts
- Impact-resistant thermoplastic cover and body
- Available in 15A and 20A versions, all with Fed Spec rating
- TEST and RESET button colors match device face
- Compatible with wallplates; available in select wallplates colors
- Limited Two-Year Product Warranty

Tamper-Resistant (TR) Models

- Complies with UL/CUL requirement mandating that all 15A and 20A receptacles installed in dwelling units be listed as tamper-resistant
- Shutter mechanism inside the receptacle blocks access to the contacts unless a two- or three-prong plug is inserted

Duplex Guide Light Models

- Green optional indicator light and life end alarm with red indicator light

Weather-Resistant Models

- **Anti-UV radiation PC Material.**

Applications

Residential

- Kitchens, bathrooms, garages, basements, laundry rooms, wet sink and other wet locations around the home

Educational Facilities

- Classrooms, restrooms, laboratories, dormitories and kitchens

Airports

- Public bathrooms, general use and maintenance areas

Restaurants, Lodging and Retail Malls

- Public bathrooms, general use and maintenance areas

Commercial Offices

- Bathrooms, basement areas, hallways and kitchen facilities

Public Areas

- Wherever receptacles are located near wet or damp locations

Application: Used for industrial generators and other machines.



TG15

DESCRIPTION

GFCI Duplex Receptacle
15A 125V AC 60Hz
Self-Test UL943

ART. NO

TG15 WH
TG15 IV
TG15 AL
TG15 BK
TG15GR

BODY COLOR

White
Ivory
Almond
Black
Grey



TG20

DESCRIPTION

GFCI Duplex Receptacle
20A 125V AC 60Hz
Self-Test UL943

ART. NO

TG20 WH
TG20 IV
TG20 AL
TG20 BK
TG20 GR

BODY COLOR

White
Ivory
Almond
Black
Grey



TGT15

DESCRIPTION

GFCI Duplex Receptacle
15A 125V AC 60Hz
Tamper Resistant
Weather Resistant
Self-Test UL943

ART. NO

TGT15 WH
TGT15 IV
TGT15 AL
TGT15 BK
TGT15GR

BODY COLOR

White
Ivory
Almond
Black
Grey

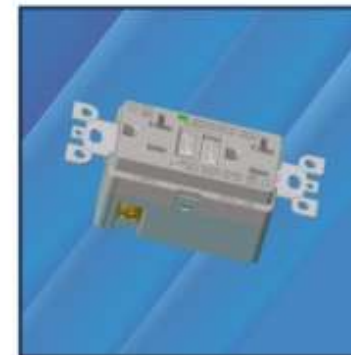

TGT20

DESCRIPTION

GFCI Duplex Receptacle
20A 125V AC 60Hz
Tamper Resistant
Weather Resistant
Self-Test UL943

ART. NO

TGT20 WH
TGT20 IV
TGT20 AL
TGT20 BK
TGT20 GR

BODY COLOR

White
Ivory
Almond
Black
Grey





Various kinds of colors available

2010 Regular GFCI Series Characteristics:

- 15A/20A, 125VAC, 60Hz Feed Through
- Back and side wired
- Various colors available
- Red/Blue button(or at your option)
- Optional wall plate

Applications:

2010 Regular GFCI Series should be used anywhere an electrical shock is likely to occur. Be sure to install GFCI in the locations such as: Indoor kitchen, hospital ,hygiene equipment-laundry room, school, airport, office and so on.

Installation Wiring Diagram

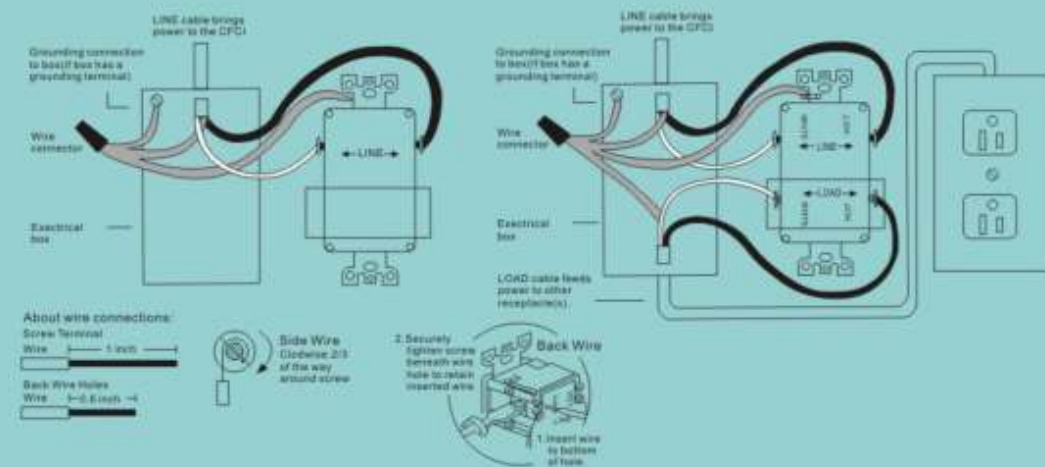
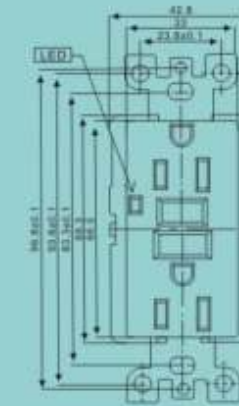
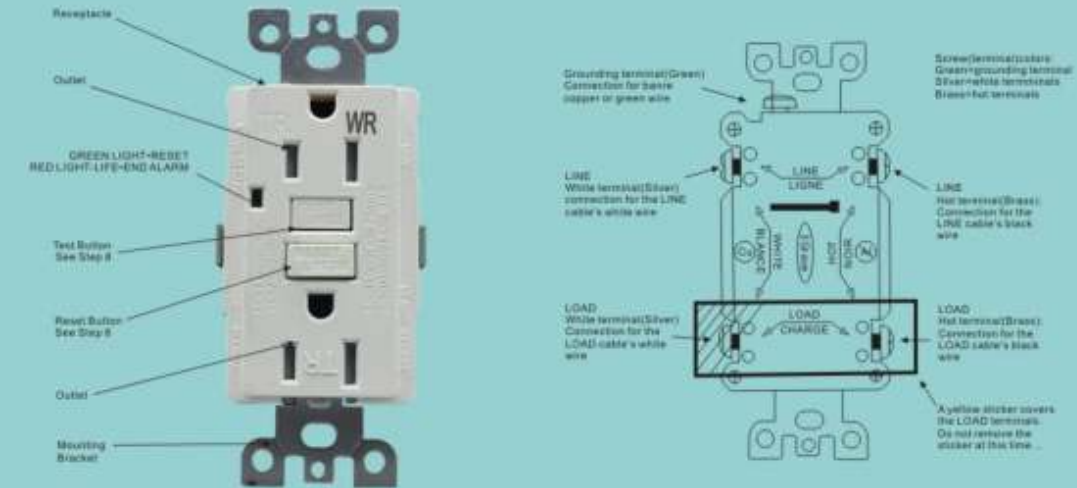



TGM15

DESCRIPTION

GFCI Duplex
15A 125V AC.
With Led indicator.

ART. NO

TGM15 WH
TGM15 IV
TGM15 AL
TGM15 BK
TGM15 GR

BODY COLOR

White
Ivory
Almond
Black
Grey



TGM20

DESCRIPTION

GFCI Duplex
20A 125V AC.
With Led indicator.

ART. NO

TGM20 WH
TGM20 IV
TGM20 AL
TGM20 BK
TGM20 GR

BODY COLOR

White
Ivory
Almond
Black
Grey



TGMT15

DESCRIPTION

GFCI Duplex
15A 125V AC.
With Led indicator.
Tamper Resistant.

ART. NO

TGMT15 WH
TGMT15 IV
TGMT15 AL
TGMT15 BK
TGMT15 GR

BODY COLOR

White
Ivory
Almond
Black
Grey



TGMT20

DESCRIPTION

GFCI Duplex
20A 125V AC.
With Led indicator.
Tamper Resistant.

ART. NO

TGMT20 WH
TGMT20 IV
TGMT20 AL
TGMT20 BK
TGMT20 GR

BODY COLOR

White
Ivory
Almond
Black
Grey



TGMT15WR

DESCRIPTION

GFCI Duplex
15A 125V AC.
With Led indicator.
Tamper Resistant &
Weather Resistant.

ART. NO

TGMT15WR WH
TGMT15WR IV
TGMT15WR AL
TGMT15WR BK
TGMT15WR GR

BODY COLOR

White
Ivory
Almond
Black
Grey



TGMT20WR

DESCRIPTION

GFCI Duplex
20A 125V AC.
With Led indicator.
Tamper Resistant &
Weather Resistant.

ART. NO

TGMT20WR WH
TGMT20WR IV
TGMT20WR AL
TGMT20WR BK
TGMT20WR GR

BODY COLOR

White
Ivory
Almond
Black
Grey



TGM-I

DESCRIPTION

Dead Front GFCI
20A 125V AC.
With Led indicator.

ART. NO

TGM-I WH
TGM-I IV
TGM-I AL
TGM-I BK
TGM-I GR

BODY COLOR

White
Ivory
Almond
Black
Grey



5VDC 2.1A/4.2A Max output for Fast Charging. Smart Identification Chip to output optimal power and protect them from overcharging or overheating.



SXUT1521

DESCRIPTION

USB charger receptacle
15A 125V, Tamper resistant
2.1A 5VDC USB output

ART. NO

SXUT1521 WH
SXUT1521 IV
SXUT1521 AL
SXUT1521 BK
SXUT1521 GR

BODY COLOR

White
Ivory
Almond
Black
Grey



SXUT2021

DESCRIPTION

USB charger receptacle
20A 125V, Tamper resistant
2.1A 5VDC USB output

ART. NO

SXUT2021 WH
SXUT2021 IV
SXUT2021 AL
SXUT2021 BK
SXUT2021 GR

BODY COLOR

White
Ivory
Almond
Black
Grey



SXUT1542

DESCRIPTION

NEMA 5-15R, 15 Amp, 125Volt Duplex Receptacle With 2 USB Ports. Provides 4.2 Amps of Charging Power. It Has The Capability To Charge Two USB Powered Electronic Devices Utilizing its Two USB Ports, Leaving The Two Tamper Resistant Outlets Free For Other Uses.

ART. NO

SXUT1542 WH
SXUT1542 IV
SXUT1542 AL
SXUT1542 BK
SXUT1542 GR

BODY COLOR

White
Ivory
Almond
Black
Grey



SXUT2042

DESCRIPTION

NEMA 5-20R, 20 Amp, 125Volt Duplex Receptacle With 2 USB Ports. Provides 4.2 Amps of Charging Power. It Has The Capability To Charge Two USB Powered Electronic Devices Utilizing its Two USB Ports, Leaving The Two Tamper Resistant Outlets Free For Other Uses.

ART. NO

SXUT2042 WH
SXUT2042 IV
SXUT2042 AL
SXUT2042 BK
SXUT2042 GR

BODY COLOR

White
Ivory
Almond
Black
Grey



Standard Duplex Receptacle



TMSR15/1J

DESCRIPTION

Standard Duplex Receptacle
15A 125V AC With
Self-Grounding Clip and
Standard Wire

COLOR

White
Ivory
Almond
Black
Grey

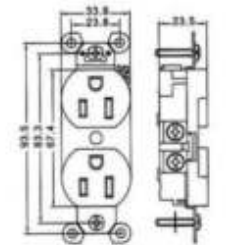

TMSR15/2J

DESCRIPTION

Standard Duplex Receptacle
15A 125V AC With
Self-Grounding Clip and
Quick wire

COLOR

White
Ivory
Almond
Black
Grey

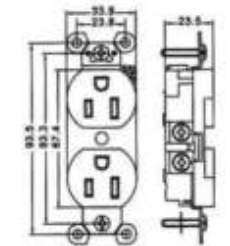

TMSR20/1J

DESCRIPTION

Standard Duplex Receptacle
20A 125V AC With
Self-Grounding Clip and
Standard Wire

COLOR

White
Ivory
Almond
Black
Grey

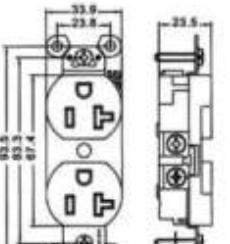

TMSR15/250

DESCRIPTION

Standard Duplex Receptacle
15A 250V AC With
Self-Grounding Clip and
quick wire.

COLOR

White
Ivory
Almond
Black
Grey

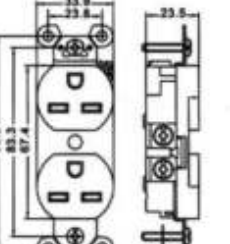

Standard Duplex Receptacle



TMSR20/250

DESCRIPTION

Standard Duplex Receptacle
20A 250V AC With
Self-Grounding Clip and
Standard Wire

COLOR

White
Ivory
Almond
Black
Grey

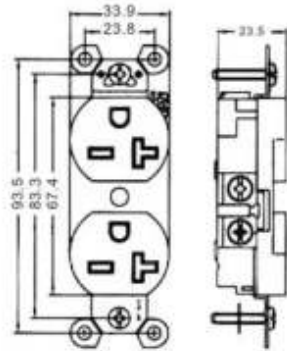

TST15-1J

DESCRIPTION

Standard Duplex Receptacle
15A 125V AC Tamper
Resistant With
Self-Grounding Clip and
quick wire

COLOR

White
Ivory
Almond
Black
Grey

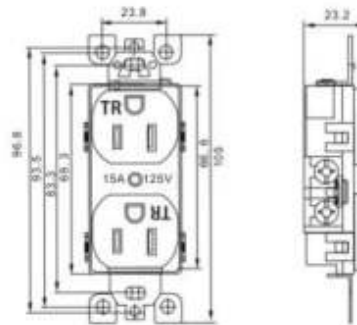

TST20-1J

DESCRIPTION

Standard Duplex Receptacle
20A 125V AC Tamper
Resistant With
Self-Grounding Clip and
Standard Wire

COLOR

White
Ivory
Almond
Black
Grey

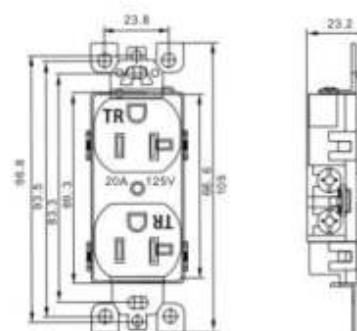

TCT15-1J

DESCRIPTION

Standard Duplex Receptacle
15A 125V AC Tamper
Resistant With
Self-Grounding Clip and
Standard Wire

COLOR

White
Ivory
Almond
Black
Grey

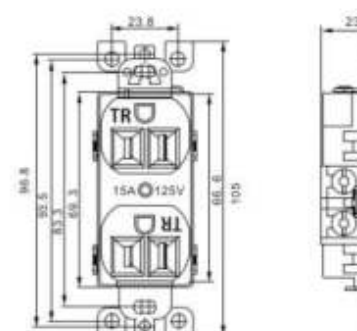

Standard Duplex Receptacle



TCT20-1J

DESCRIPTION

Standard Duplex Receptacle
20A 125V AC Tamper
Resistant With
Self-Grounding Clip and
Standard Wire

COLOR

White
Ivory
Almond
Black
Grey

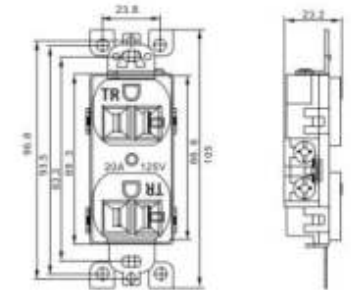

TSTW15-1J

DESCRIPTION

Standard Duplex Receptacle
15A 125V AC Tamper
Resistant & Weather
Resistant With
Self-Grounding Clip and
Standard Wire

COLOR

White
Ivory
Almond
Black
Grey

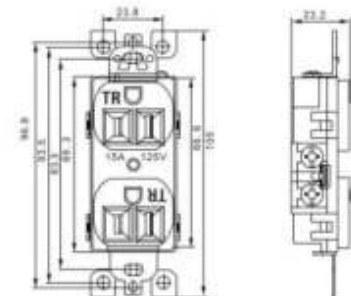

TSTW20-1J

DESCRIPTION

Standard Duplex Receptacle
20A 125V AC Tamper
Resistant & Weather
Resistant With
Self-Grounding Clip and
Standard Wire

COLOR

White
Ivory
Almond
Black
Grey

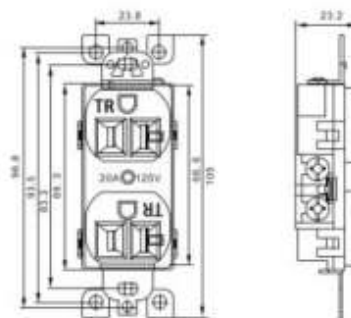

TCTW15-1J

DESCRIPTION

Standard Duplex Receptacle
15A 125V AC Tamper
Resistant & Weather
Resistant With
Self-Grounding Clip and
Standard Wire

COLOR

White
Ivory
Almond
Black
Grey

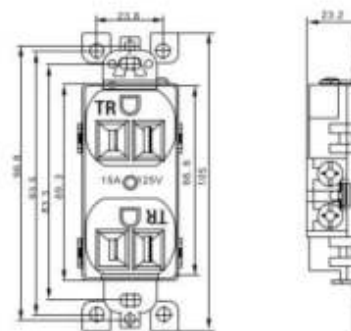

Standard Duplex Receptacle



TCTW20-1J

DESCRIPTION

Standard Duplex Receptacle
20A 125V AC Tamper
Resistant & Weather
Resistant With
Self-Grounding Clip and
Standard Wire

COLOR

White
Ivory
Almond
Black
Grey

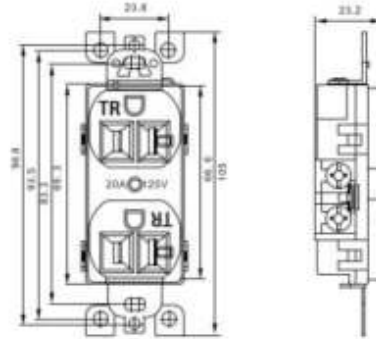

Single Receptacle



TMBR15

DESCRIPTION

Single Receptacle
15A 125V AC With
Self-Grounding
Clip and Standard Wire

COLOR

White
Ivory
Almond
Black
Grey

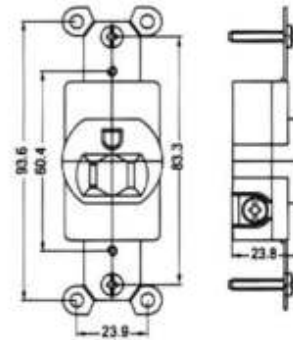

TMBR20

DESCRIPTION

Single Receptacle
125V AC 20A With
Self-Grounding
Clip and Standard Wire

COLOR

White
Ivory
Almond
Black
Grey

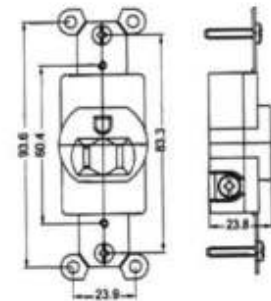

TMBR15/250

DESCRIPTION

Single Receptacle
250V AC 15A With
Self-Grounding
Clip and Standard Wire

COLOR

White
Ivory
Almond
Black
Grey

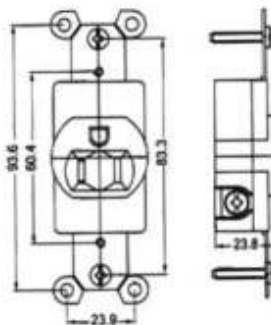

Single Receptacle



TMBR20/250

DESCRIPTION

Single Receptacle
15A 125V AC With
Self-Grounding
Clip and Standard Wire

COLOR

White
Ivory
Almond
Black
Grey

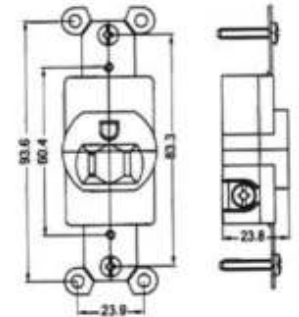

Decorative Duplex Receptacle



TMDR15/1J

DESCRIPTION

Decorative Duplex
Receptacle
15A 125V AC With
Self-Grounding
Clip and Standard Wire

COLOR

White
Ivory
Almond
Black
Grey

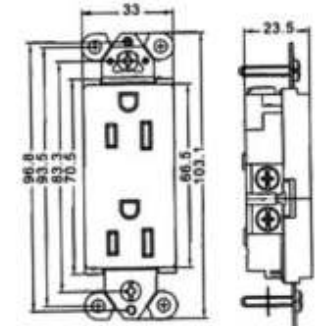

TMDR15/2J

DESCRIPTION

Decorative Duplex
Receptacle
15A 125V AC With
Self-Grounding
Clip and Quick Wire

COLOR

White
Ivory
Almond
Black
Grey

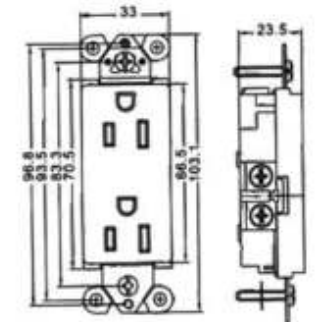

TMDR20/1J

DESCRIPTION

Decorative Duplex
Receptacle
20A 125V AC With
Self-Grounding
Clip and Standard Wire

COLOR

White
Ivory
Almond
Black
Grey

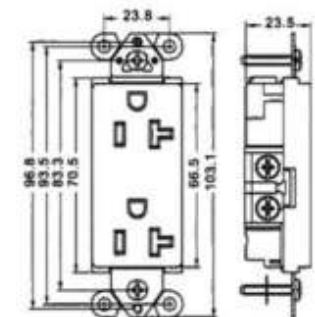

Decorative Duplex Receptacle



TDT15-1J

DESCRIPTION

Decorative Duplex Receptacle
15A 125V AC Tamper Resistant With Self-Grounding Clip and Standard Wire

COLOR

White
Ivory
Almond
Black
Grey

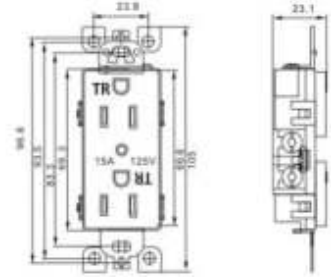

TDT20-1J

DESCRIPTION

Decorative Duplex Receptacle
20A 125V AC Tamper Resistant With Self-Grounding Clip and Standard Wire

COLOR

White
Ivory
Almond
Black
Grey

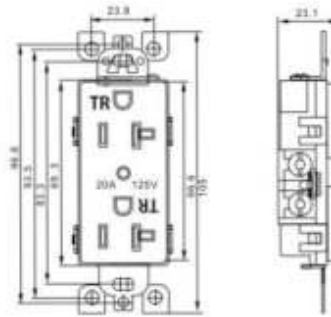

TDTW15-1J

DESCRIPTION

Decorative Duplex Receptacle
15A 125V AC Tamper Resistant & Weather Resistant With Self-Grounding Clip and Standard Wire

COLOR

White
Ivory
Almond
Black
Grey

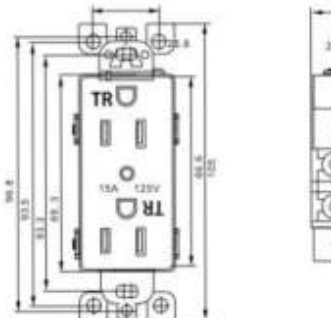

TDTW20-1J

DESCRIPTION

Decorative Duplex Receptacle
20A 125V AC Tamper Resistant & Weather Resistant With Self-Grounding Clip and Standard Wire

COLOR

White
Ivory
Almond
Black
Grey

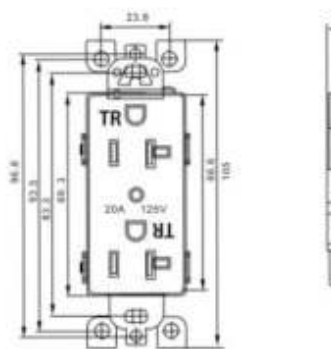

Toggle Switches



TM-1

DESCRIPTION

Single Pole toggle switch
15A 125V AC Push in and side wire

COLOR

White
Ivory
Almond
Black
Grey

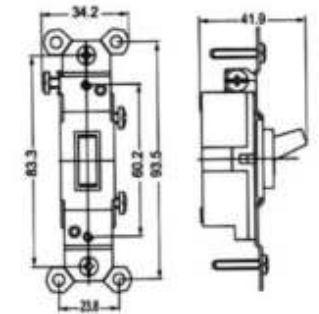

TM-2

DESCRIPTION

3-ways toggle switch
15A 125V AC Push in and side wire

COLOR

White
Ivory
Almond
Black
Grey

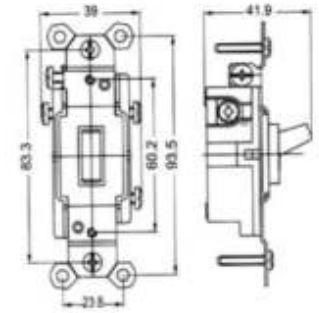

TM-3

DESCRIPTION

4-ways toggle switch
15A 125V AC Push in and side wire

COLOR

White
Ivory
Almond
Black
Grey

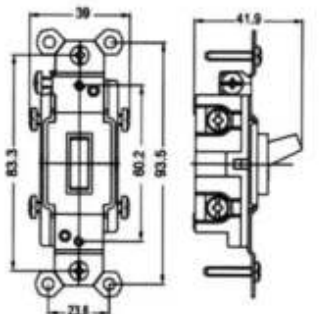

Decorative Switch

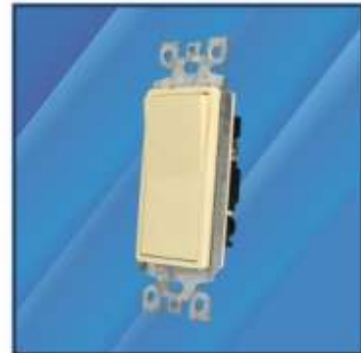

TM-4

DESCRIPTION

Single Pole
Decorative switch
15A 125V /227V AC
Push in and side wire

COLOR

White
Ivory
Almond
Black
Grey

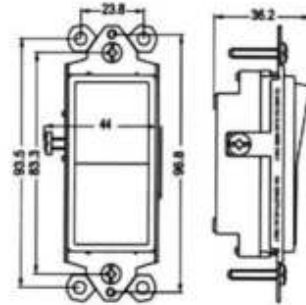

TM-5

DESCRIPTION

3-ways
Decorative switch
15A 125V /227V AC
Push in and side wire

COLOR

White
Ivory
Almond
Black
Grey

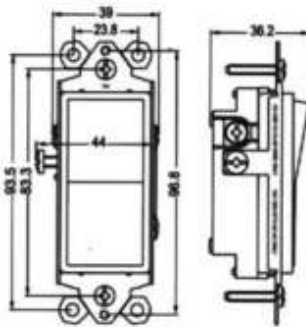

TM-6

DESCRIPTION

4-ways
Decorative switch
15A 125V /227V AC
Push in and side wire

COLOR

White
Ivory
Almond
Black
Grey

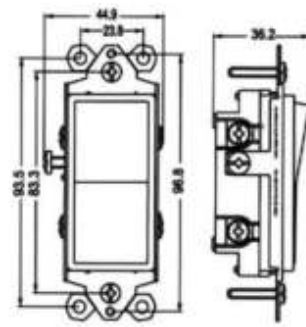

CHYT Face plate has the best function as well as nice appearance. To guarantee it's good quality, use the reliable plastic material. The various colors, surge immunity and stability can meet your different needs of the products.

- ETL certificate
- UL File No. E247613
- Surge Immunity
- Conform the requirements of National Electric Manufacturing Association(NEMA) and American National Standardization Association(ANSI)
- Screws individually wrapped in a small plastic bag to protect plates from scratches
- Round on edges to prevent injury and wall damage
- Screws color matches plate color



T9603

DESCRIPTION

1 Gang
Decroative/GFCI
Plate Include
2pc Screws
2 3/4"X4 1/2"

ART. NO

T9603-AL
T9603-DE
T9603-BL
T9603-GR
T9603-IV
T9603-WH

COLOR

Almond
Deep-almond
Black
Gray
Ivory
White



T9603-1

DESCRIPTION

2 Gang Decroative/GFCI
Plate Include 4pc Screws
4 9/16"X4 1/2"

ART. NO

T9603-1 AL
T9603-1 DE
T9603-1 BL
T9603-1 GR
T9603-1 IV
T9603-1 WH

COLOR

Almond
Deep-almond
Black
Gray
Ivory
White





T9603-2

DESCRIPTION

3 Gang
Decroative/GFCI
Plate Include
6pc Screws
63/8"X4 1/2"

ART. NO

T9603-2 AL
T9603-2 DE
T9603-2 BL
T9603-2 GR
T9603-2 IV
T9603-2 WH

COLOR

Almond
Deep-almond
Black
Gray
Ivory
White



T9603-3

DESCRIPTION

4 Gang
Decroative/GFCI
Plate Include
8pc Screws
8 1/5"X4 1/2"

ART. NO

T9603-3 AL
T9603-3 DE
T9603-3 BL
T9603-3 GR
T9603-3 IV
T9603-3 WH

COLOR

Almond
Deep-almond
Black
Gray
Ivory
White



T9603-4

DESCRIPTION

5 Gang
Decroative/GFCI
Plate Include
10pc Screws
10"X4 1/2"

ART. NO

T9603-4 AL
T9603-4 DE
T9603-4 BL
T9603-4 GR
T9603-4 IV
T9603-4 WH

COLOR

Almond
Deep-almond
Black
Gray
Ivory
White



T9603-6

DESCRIPTION

1 Gang Mid
Decroative/GFCI
Plate Include
2pc Screws
3.2"X4.87"

ART. NO

T9603-6 AL
T9603-6 DE
T9603-6 BL
T9603-6 GR
T9603-6 IV
T9603-6 WH

COLOR

Almond
Deep-almond
Black
Gray
Ivory
White



T9603-D

DESCRIPTION

1 Gang
Decroative/GFCI
Plate Include Without
Screws On the cover

ART. NO

T9603-D AL
T9603-D DE
T9603-D BL
T9603-D GR
T9603-D IV
T9603-D WH

COLOR

Almond
Deep-almond
Black
Gray
Ivory
White



T9603-C

DESCRIPTION

1 Gang
Decroative/GFCI
Plate Include Without
Screws On the cover

ART. NO

T9603-C AL
T9603-C DE
T9603-C BL
T9603-C GR
T9603-C IV
T9603-C WH

COLOR

Almond
Deep-almond
Black
Gray
Ivory
White



T9601-1

DESCRIPTION

1 Gang Toggle Switch
Plate Include
2pc Screws
2 3/4"X4 1/2"

ART. NO

T9601-1 AL
T9601-1 DE
T9601-1 BL
T9601-1 GR
T9601-1 IV
T9601-1 WH

COLOR

Almond
Deep-almond
Black
Gray
Ivory
White



T9601-2

DESCRIPTION

2 Gang
Toggle Switch
Plate Include
4pc Screws
4 9/16"X4 1/2"

ART. NO

T9601-2 AL
T9601-2 DE
T9601-2 BL
T9601-2 GR
T9601-2 IV
T9601-2 WH

COLOR

Almond
Deep-almond
Black
Gray
Ivory
White





T9601-3

DESCRIPTION

3 Gang Toggles Switch
Plate Include
6pcs Screws
63/8"X4 1/2"

ART. NO

T9601-3 AL
T9601-3 DE
T9601-3 BL
T9601-3 GR
T9601-3 IV
T9601-3 WH

COLOR

Almond
Deep-almond
Black
Gray
Ivory
White



T9601-4

DESCRIPTION

4 Gang Toggles Switch
Plate Include
8pcs Screws
8 1/5"X4 1/2"

ART. NO

T9601-4 AL
T9601-4 DE
T9601-4 BL
T9601-4 GR
T9601-4 IV
T9601-4 WH

COLOR

Almond
Deep-almond
Black
Gray
Ivory
White



T9601-5

DESCRIPTION

5 Gang Toggles Switch
Plate Include
10pcs Screws
10"X4 1/2"

ART. NO

T9601-5 AL
T9601-5 DE
T9601-5 BL
T9601-5 GR
T9601-5 IV
T9601-5 WH

COLOR

Almond
Deep-almond
Black
Gray
Ivory
White



T9601-6

DESCRIPTION

Red Emergency "Gas"
ON/OFF Switch Plates

ART. NO

T9601-6

COLOR

Red



T9602-1

DESCRIPTION

1 Gang Duplex
Plate Include
1pc Screws
2 3/4"X4 1/2"

ART. NO

T9602-1 AL
T9602-1 DE
T9602-1 BL
T9602-1 GR
T9602-1 IV
T9602-1 WH

COLOR

Almond
Deep-almond
Black
Gray
Ivory
White



T9602-2

DESCRIPTION

2 Gang Duplex
Plate Include
2pc Screws
4 9/16"X4 1/2"

ART. NO

T9602-2 AL
T9602-2 DE
T9602-2 BL
T9602-2 GR
T9602-2 IV
T9602-2 WH

COLOR

Almond
Deep-almond
Black
Gray
Ivory
White



T9604-9

DESCRIPTION

1 Gang Single Receptacle
1.405" Dia
1 Gang
2 3/4"X4 1/2"

ART. NO

T9604-9 AL
T9604-9 DE
T9604-9 BL
T9604-9 GR
T9604-9 IV
T9604-9 WH

COLOR

Almond
Deep-almond
Black
Gray
Ivory
White



T9604-10

DESCRIPTION

2 Gang Single Receptacle
1.405" Dia
2Gang
4 9/16"X4 1/2"

ART. NO

T9604-10 AL
T9604-10 DE
T9604-10 BL
T9604-10 GR
T9604-10 IV
T9604-10 WH

COLOR

Almond
Deep-almond
Black
Gray
Ivory
White





T9604-1

DESCRIPTION

2 Gang 1 Toggle, 1 Decroative/GFCI Include 4pc Screws 49/16"X4 1/2"

ART. NO

T9604-1 AL
T9604-1 DE
T9604-1 BL
T9604-1 GR
T9604-1 IV
T9604-1 WH

COLOR

Almond
Deep-almond
Black
Gray
Ivory
White



T9604-2

DESCRIPTION

2 Gang 1 Toggle, 1 Duplex Include 3pc Screws 49/16"X4 1/2"

ART. NO

T9604-2 AL
T9604-2 DE
T9604-2 BL
T9604-2 GR
T9604-2 IV
T9604-2 WH

COLOR

Almond
Deep-almond
Black
Gray
Ivory
White



T9604-3

DESCRIPTION

2 Gang 1 Toggle, 1 Blank Include 4pc Screws 49/16"X4 1/2"

ART. NO

T9604-3 AL
T9604-3 DE
T9604-3 BL
T9604-3 GR
T9604-3 IV
T9604-3 WH

COLOR

Almond
Deep-almond
Black
Gray
Ivory
White



T9604-4

DESCRIPTION

2 Gang 1 Toggle, Decroative/GFCI, 1 Duplex Include 3pc Screws 49/16"X4 1/2"

ART. NO

T9604-4 AL
T9604-4 DE
T9604-4 BL
T9604-4 GR
T9604-4 IV
T9604-4 WH

COLOR

Almond
Deep-almond
Black
Gray
Ivory
White



T9604-5

DESCRIPTION

2 Gang 1 Blank, 1 Decroative/GFCI, Include 4pc Screws 49/16"X4 1/2"

ART. NO

T9604-5 AL
T9604-5 DE
T9604-5 BL
T9604-5 GR
T9604-5 IV
T9604-5 WH

COLOR

Almond
Deep-almond
Black
Gray
Ivory
White



T9604-6

DESCRIPTION

2 Gang 1 Blank, 1 Duplex Include 4pc Screws 49/16"X4 1/2"

ART. NO

T9604-6 AL
T9604-6 DE
T9604-6 BL
T9604-6 GR
T9604-6 IV
T9604-6 WH

COLOR

Almond
Deep-almond
Black
Gray
Ivory
White



T9604-7

DESCRIPTION

3 Gang 1 Decorative/GFCI 2Toggle Include 6pcs Screws 63/16 " X4 1/2 "

ART.NO.

T9604-7AL
T9604-7DE
T9604-7BL
T9604-7GR
T9604-7IV
T9604-7WH

COLOR

ALMOND
DEEP-ALMOND
BLACK
GRAY
IVORY
WHITE



T9604-8

DESCRIPTION

1 Gang Cable/Phone Plate Include 2pcs Screws 23/4 " X4 1/2 "

ART.NO.

T9604-8AL
T9604-8DE
T9604-8BL
T9604-8GR
T9604-8IV
T9604-8WH

COLOR

ALMOND
DEEP-ALMOND
BLACK
GRAY
IVORY
WHITE





T9607

DESCRIPTION

1 Gang Blank Plate Include
2pc Screws
2 3/4" X 4 1/2"

ART. NO

T9607 AL
T9607 DE
T9607 BL
T9607 GR
T9607 IV
T9607 WH

COLOR

Almond
Deep-almond
Black
Gray
Ivory
White



T9607-1

DESCRIPTION

2 Gang Blank Plate Include
4pc Screws
4 9/16" X 4 1/2"

ART. NO

T9607-1 AL
T9607-1 DE
T9607-1 BL
T9607-1 GR
T9607-1 IV
T9607-1 WH

COLOR

Almond
Deep-almond
Black
Gray
Ivory
White



T9605-1

DESCRIPTION

Shallow Wallbox Extender for GFCIs

ART. NO

T9605-2 AL
T9605-2 DE
T9605-2 BL
T9605-2 GR
T9605-2 IV
T9605-2 WH

COLOR

Almond
Deep-almond
Black
Gray
Ivory
White



T9605-2

DESCRIPTION

Shallow Wallbox Extender for GFCIs

ART. NO

T9605-2 AL
T9605-2 DE
T9605-2 BL
T9605-2 GR
T9605-2 IV
T9605-2 WH

COLOR

Almond
Deep-almond
Black
Gray
Ivory
White



TS9603

DESCRIPTION

Steel Stainless decorative /GFCI Wall Plate

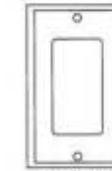

TS9603-1

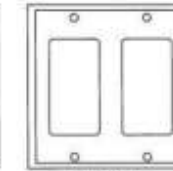

TS9603-2

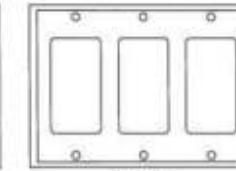

TS9603-3

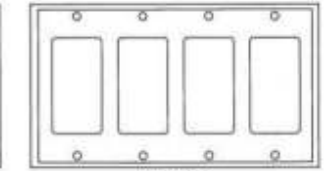

TS9603-4



TS9602

DESCRIPTION

Steel Stainless Standard Duplex Receptacle Wall Plate

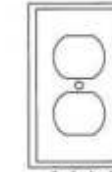

TS9602-1

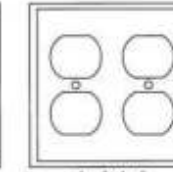

TS9602-2

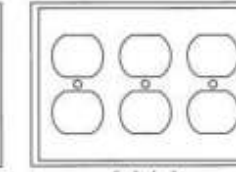

TS9602-3

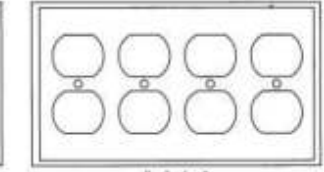

TS9602-4



TS9607

DESCRIPTION

Steel Stainless Blank Wall Plate



TS9607-1

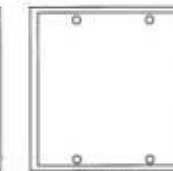

TS9607-2

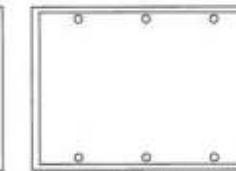

TS9607-3

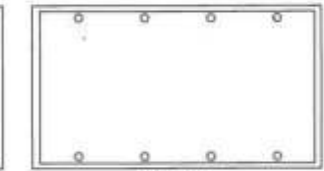

TS9607-4



TS9601

DESCRIPTION

Steel Stainless Toggle Switch Wall Plate

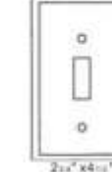

TS9601-1

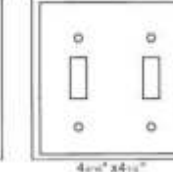

TS9601-2

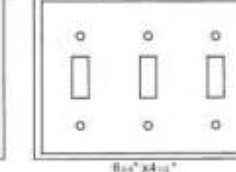

TS9601-3

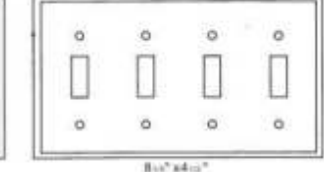

TS9601-4